



UR35

Industrial Cellular Router
Quick Start Guide



Welcome

Thank you for choosing Ursalink UR35 industrial cellular router.

This guide describes how to install the UR35 and how to log in the Web GUI to configure the device. Once you complete the installation, refer to the Ursalink UR35 User Guide for instructions on how to perform configurations on the device.

Related Documents

This Start Guide only explains the installation of Ursalink UR35 router. For more functionality and advanced settings, please refer to the relevant documents as below.

Document	Description
Ursalink UR35 Datasheet	Datasheet for the Ursalink UR35 industrial cellular router.
Ursalink UR35 User Guide	Users could refer to the guide for instruction on how to log in the web GUI, and how to configure all the settings.

The related documents are available on Ursalink website: <http://www.ursalink.com>.

Declaration of Conformity

UR35 are in conformity with the essential requirements and other relevant provisions of the CE, FCC, and RoHS.

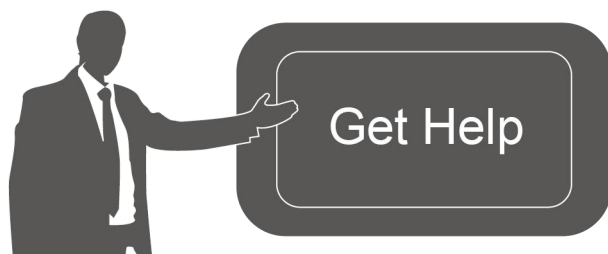

For assistance, please contact
Ursalink technical support:
Email: support@ursalink.com
Tel: 86-592-5023060
Fax: 86-592-5023065

1. Packing List

Before you begin to install the UR35 router, please check the package contents to verify that you have received the items below.

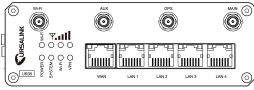

1 × UR35



1 × Ethernet Cable

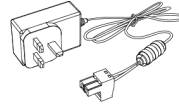

1 × Power Adapter



2 × Magnetic Mount
Cellular Antennas

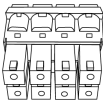

1 × 8-Pin Pluggable
Terminal

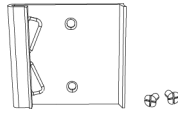

1 × DIN Rail Kit

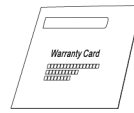

1 × Warranty Card

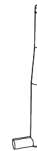

2 × Stubby Cellular
Antennas (Optional)



1 × Stubby Wi-Fi
Antenna
(Wi-Fi Version Only)



1 × GPS Antenna
(GPS Version Only)

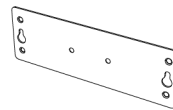

1 × Wall Mounting
Bracket (Optional)



If any of the above items is missing or damaged, please contact your Ursalink sales representative.

2. Hardware Introduction

2.1 Overview

A. Front Panel

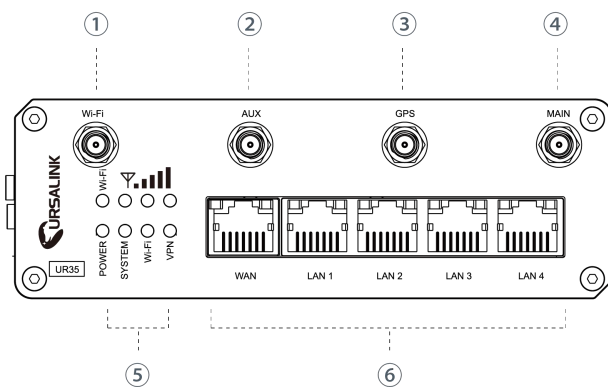

- ① Wi-Fi Antenna Connector
- ② AUX Antenna Cellular Connector
- ③ GPS Antenna Connector
- ④ MAIN Cellular Antenna Connector
- ⑤ LED Indicator Area
 - POWER: Power Indicator
 - SYSTEM: Status Indicator
 - Wi-Fi: Wi-Fi Indicator
 - VPN: VPN Indicator
 - SIM : SIM Status Indicator
 - 📶: Signal Strength Indicator
- ⑥ Ethernet Port & Indicator

B. Left Side Panel

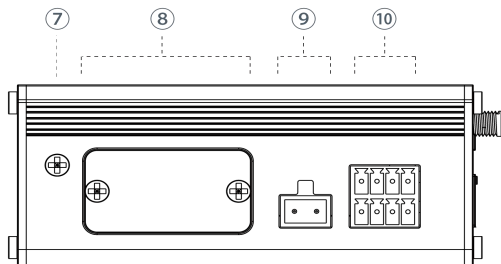

- ⑦ Grounding Stud
- ⑧ SIM and Reset Button Holder
- ⑨ Power Connector
- ⑩ Serial Port & I/O

2.2 Dimensions (mm)

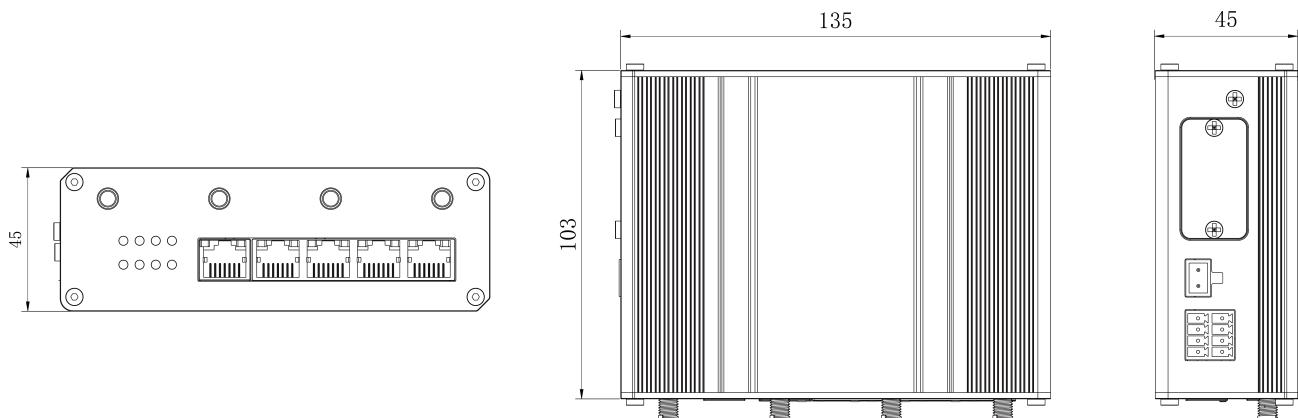

2.3 Pinouts

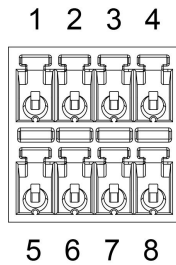

PIN	RS232	RS485	DI	DO	Description
1	---	---	IN	---	Digital Input
2	GND	---	GND	---	Ground
3	---	B	---	---	Data -
4	TXD	---	---	---	Transmit Data
5	---	---	---	COM	Common Ground
6	---	---	---	OUT	Digital Output
7	---	A	---	---	Data +
8	RXD	---	---	---	Receive Data

Note: For 2 RS485 model, RXD--->A, TXD--->B.

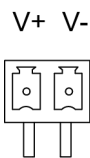

PIN	Description
9	Positive
10	Negative

2.4 LED Indicators

LED	Indication	Status	Description
POWER	Power Status	Off	The power is switched off
		On	The power is switched on
SYSTEM	System Status	Green Light	Static: Start-up
			Blinking slowly: the system is running properly
		Red Light	The system goes wrong
VPN	VPN Status	Off	VPN is disconnected
		Green Light	VPN is connected
Wi-Fi	Wi-Fi Status	Off	Wi-Fi is disabled
		Green Light	Static: Wi-Fi is enabled
SIM	SIM Card Status	Off	SIM1 or SIM2 is registering or fails to register (or there are no SIM cards inserted)
		Green Light	Blinking slowly: SIM1 (as primary SIM) has been registered and is ready for dial-up
			Blinking rapidly: SIM1(as primary SIM) has been registered and is dialing up now
			Static: SIM1 (as primary SIM) has been registered and dialed up successfully
		Orange Light	Blinking slowly: SIM2 (as primary SIM) has been registered and is ready for dial-up
Blinking rapidly: SIM2 (as primary SIM) has been			

			registered and is dialing up now
			Static: SIM2 (as primary SIM) has been registered and dialed up successfully
Signal Strength	Signal 1/2/3	Off	No signal
		Green Light	Static/Off/Off: weak signals with 1-10 ASU (please check if the antenna is installed correctly, or move the antenna to a suitable location to get better signal)
			Static/Static/Off: normal signals with 11-20 ASU (average signal strength)
			Static/Static/Static: strong signals with 21-31 ASU (signal is good)

2.5 Reset Button

Function	Description	
	SYSTEM LED	Action
Reset	Blinking	Press and hold the reset button for more than 5 seconds.
	Static Green → Rapidly Blinking	Release the button and wait.
	Off → Blinking	The router is now reset to factory defaults.

2.6 Ethernet Port Indicator

Indicator	Status	Description
Link Indicator (Orange)	On	Connected
	Blinking	Transmitting data
	Off	Disconnected

3. Hardware Installation

Environmental Requirements

- Power Input: 9-48 VDC (48 VDC is needed for PoE output)
- Power Consumption: Typical 3.9 W, Max 4.6 W
- Operating Temperature: -40°C to 70°C (-40°F -158°F)
- Relative Humidity: 0% to 95% (non-condensing) at 25°C/77°F

3.1 SIM Card/Micro SD Card Installation



UR35 do not support hot-plug. Please cut off the power before insert or take off cards.

A. Unscrew the cover of the SIM card/Micro SD then insert the card then take it off.

B. Put SIM card/Micro SD card into the slot and screw it up.

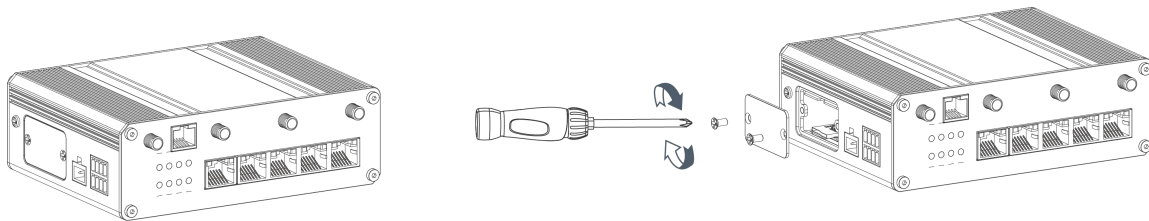

3.2 Antenna Installation

Rotate the antenna into the antenna connector accordingly.

The external antenna should be installed vertically always on a site with a good signal.

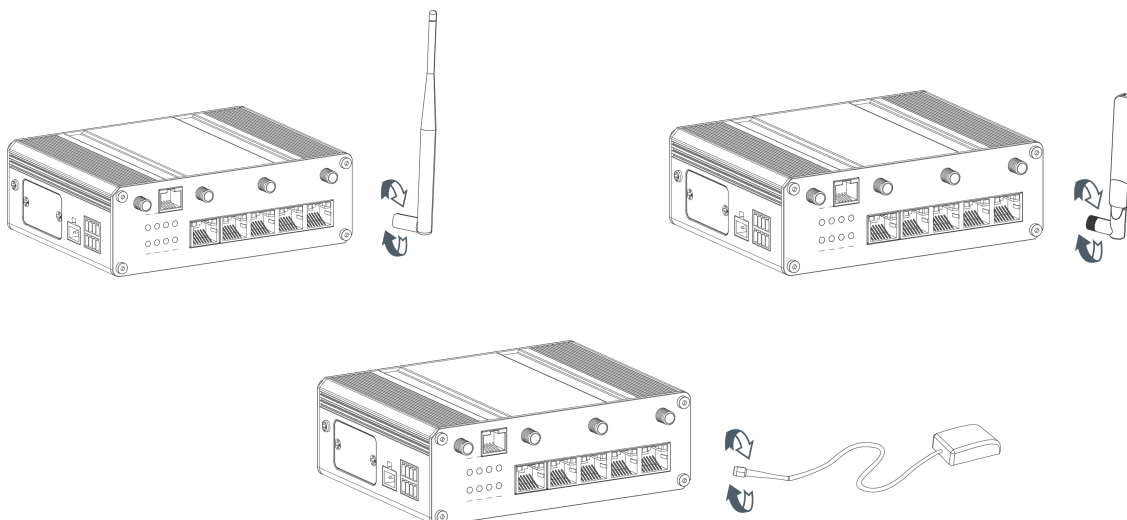

3.3 Connect the Router to a Computer

! Please connect PC to any port among LAN1-LAN4 of UR35 router directly.

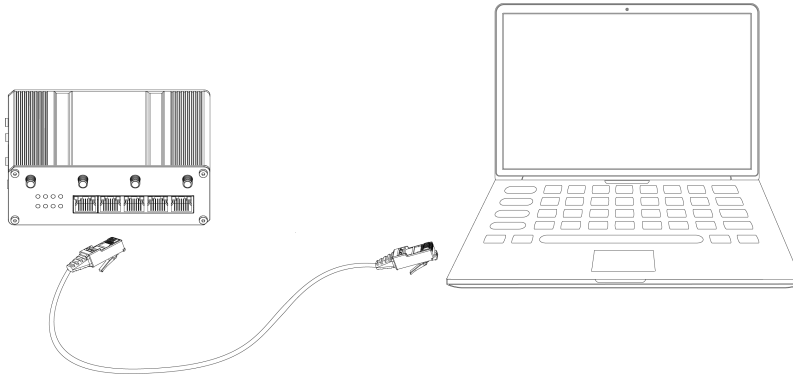

3.4 Mount the Router

The router can be placed on a desktop or mounted to a wall or a DIN rail.

3.4.1 Wall Mounting (Measured in mm)

Use 2 pcs of M3 × 6 flat head Phillips screws to fix the wall mounting kit to the router, and then use 2 pcs of M3 drywall screws to mount the router associated with the wall mounting kit on the wall.

! Recommended torque for mounting is 1.0 N·m, and the maximum allowed is 1.2 N·m.

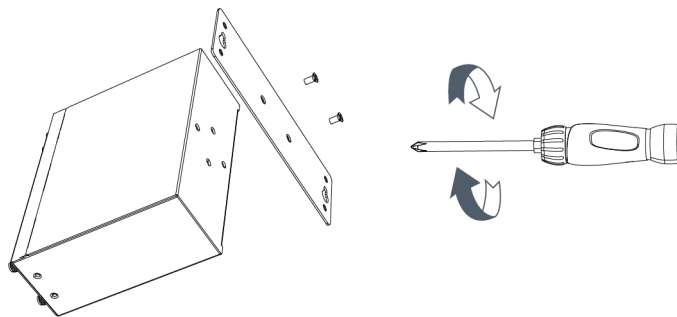

3.4.2 DIN Rail Mounting (Measured in mm)

Use 2 pcs of M3 × 6 flat head Phillips screws to fix the DIN rail to the router, and then hang the DIN rail on the mounting bracket. It is necessary to choose a standard bracket.

! Recommended torque for mounting is 1.0 N·m, and the maximum allowed is 1.2 N·m.

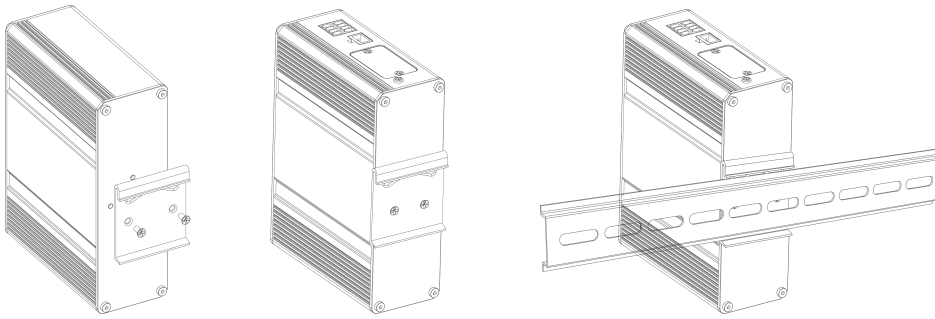

3.5 Power Supply Installation

- A. Take out the terminal from the router and unscrew the bolt on terminal.
- B. Screw down the bolt after inserting power cable into the terminal.

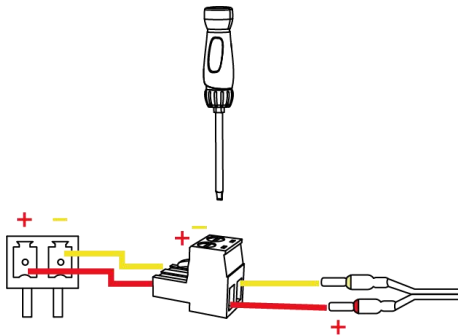

Connecting the Power Cable

Color	Polarity
Red	+
Yellow	-

! If you insert wires into the reverse holes, the router will not start and you must switch the wires into the correct holes.

3.6 Protective Grounding Installation

- A. Remove the grounding nut.
- B. Connect the grounding ring of the cabinet's grounding wire onto the grounding stud and screw up the grounding nut.

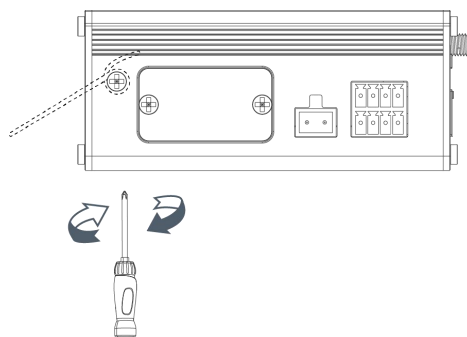

! The router must be grounded when deployed. According to operating environment, the ground wire should be connected with grounding stud of router.

Getting Started

4. PC Configuration for Web GUI Accessing to Router

Please connect PC to any port among LAN1-LAN4 of UR35 router directly. PC can obtain an IP address, or you can configure a static IP address manually. The following steps are based on Windows 10 operating system for your reference.

(Note: As remote access is disabled by default, you can't access to the router's Web GUI if you connect PC to WAN port of the router. But it will function properly if you enable it on the Web GUI.)

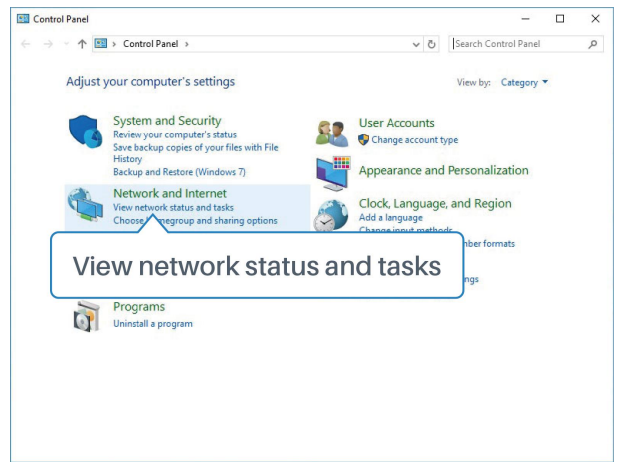
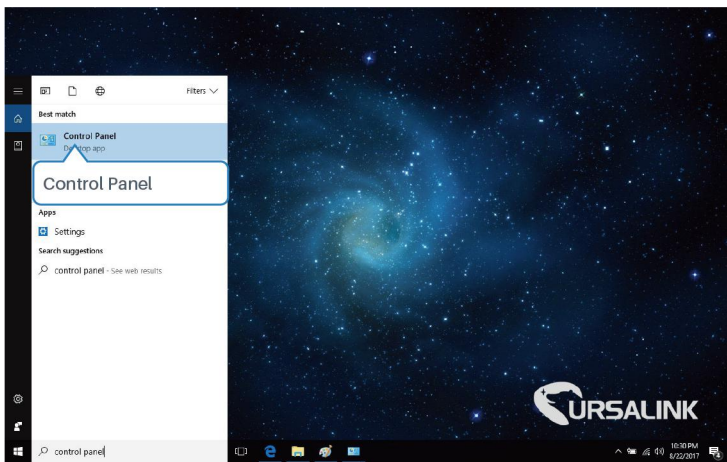

① Click “Search Box” to search “Control Panel” on the Windows 10 taskbar.

② Click “Control Panel” to open it, and then click “View network status and tasks”.

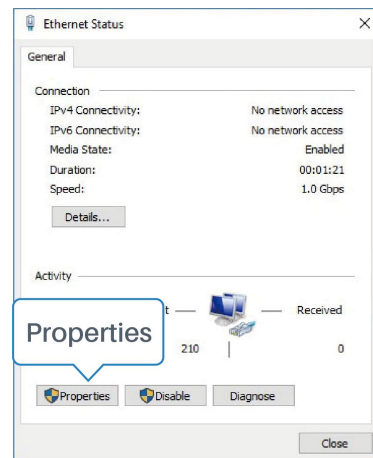
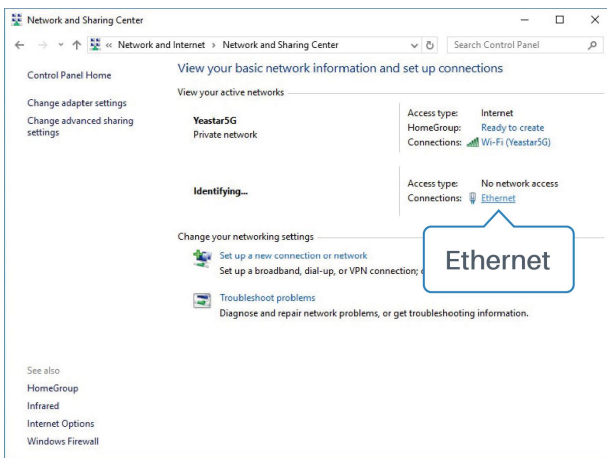

③ Click “Ethernet” (May have different names).

④ Click “Properties”.

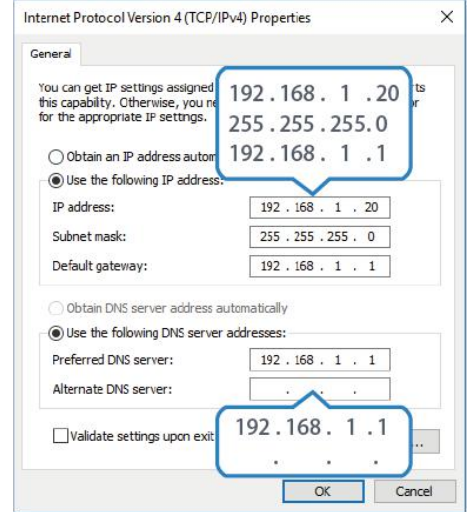
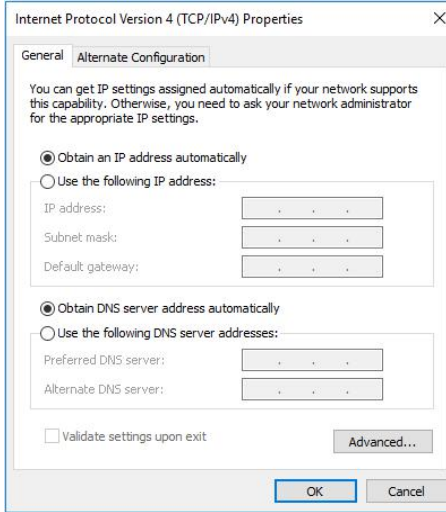
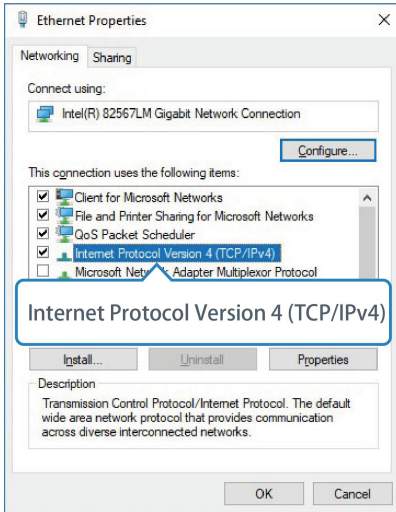

⑤ Double Click “Internet Protocol Version 4 (TCP/IPv4)” to configure IP address and DNS server.

⑥ Method 1: click “Obtain an IP address automatically”;

Method 2: click “Use the following IP address” to assign a static IP manually within the same subnet of the router.

(Note: Remember to click “OK” to finish configuration.)

5. Access to Web GUI of Router for Network Connection

This chapter explains how to log in UR35 router’s Web GUI, and connect the router to network. Ursalink router provides Web-based configuration interface for management. If this is the first time you configure the router, please use the default settings below:

- IP Address: **192.168.1.1**
- Username: **admin**
- Password: **password**

5.1 To Log in the Router

 **Make sure your PC is connected to the same network as the router as per [Section 4](#).**

- A. Start a Web browser on your PC (Chrome and IE are recommended), type in the IP address, and press Enter on your keyboard.
- B. Enter the username and password, click “Login”.

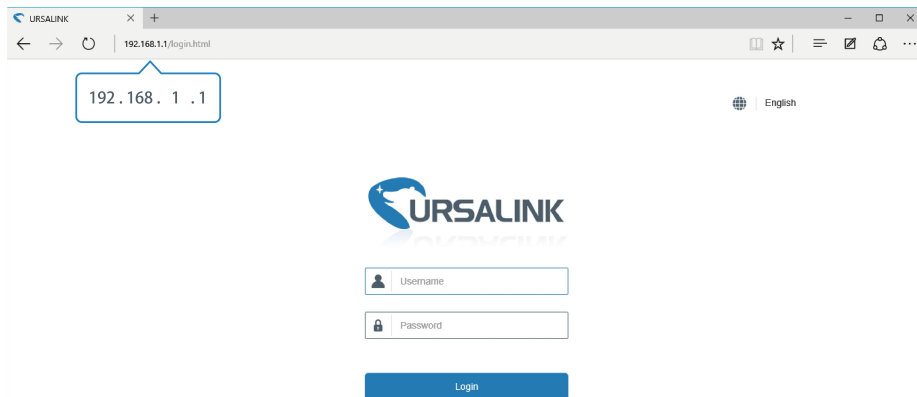

 **If you enter the username or password incorrectly more than 5 times, the login page will be locked for 10 minutes.**

C. When you log in with the default username and password, you will be asked to modify the password. It’s suggested that you change the password for the sake of security. Click “Cancel” button if you want to modify it later.

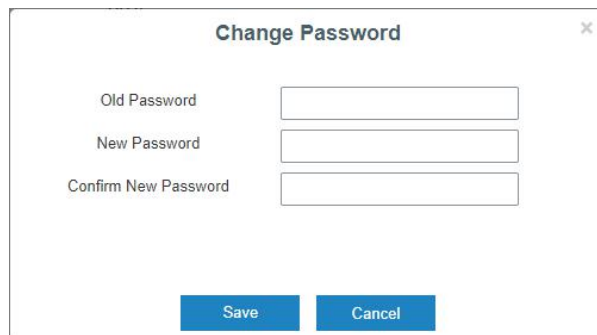

D. After you log in the Web GUI, you can view system information and perform configuration on the router.

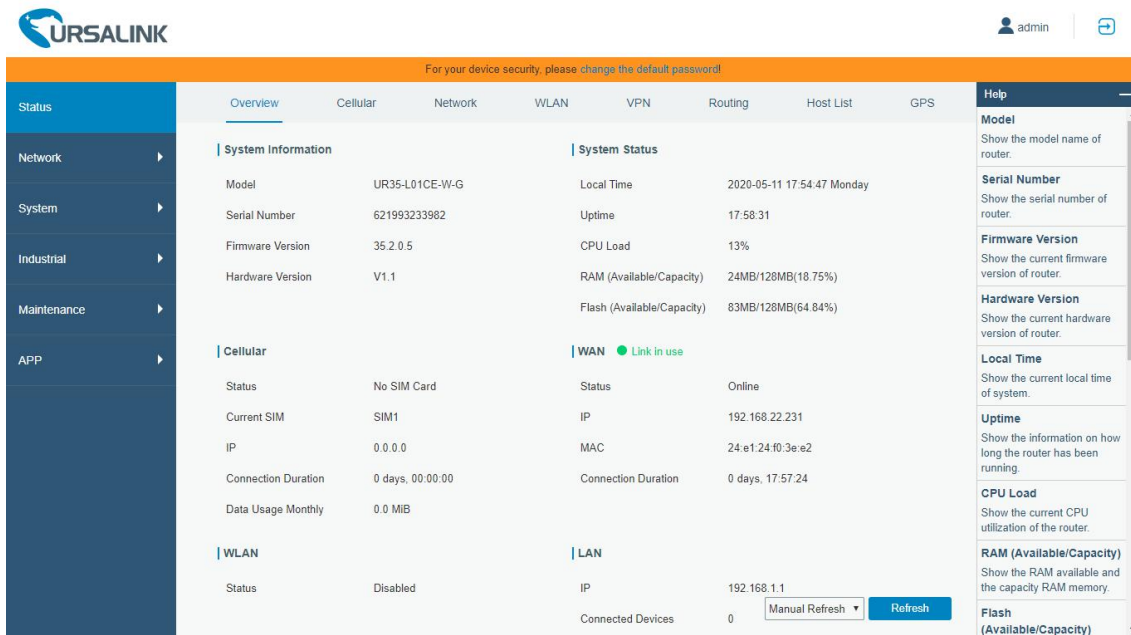

5.2 Configure the Cellular Connection

Take inserting SIM card into SIM1 slot as an example; please refer to the following detailed operations.

- Click “Network > Interface > Cellular > Cellular Setting” to configure the cellular info, like APN and network type.
- Click “Save” and “Apply” for configuration to take effect.

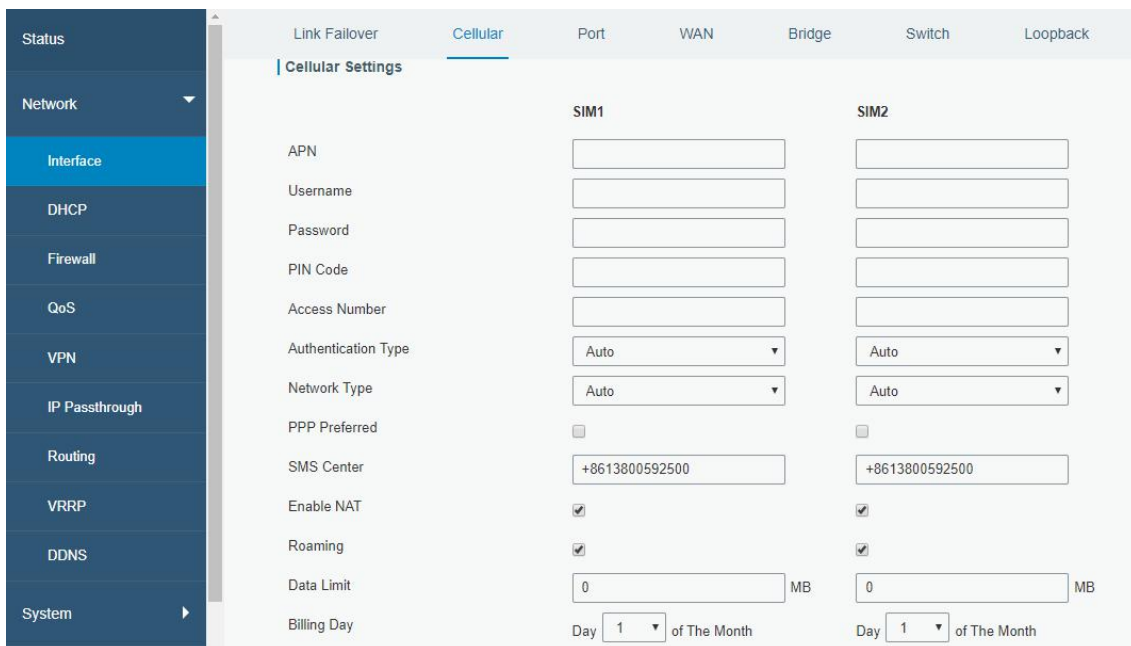

If you select “Auto”, the router will obtain ISP information from SIM card to set APN, Username, and Password automatically. This option will only be taken effect when the SIM card is issued from a well-known ISP.

- Go to “Network > Interface > Link Failover” to enable SIM1 and rise link priority of SIM1.

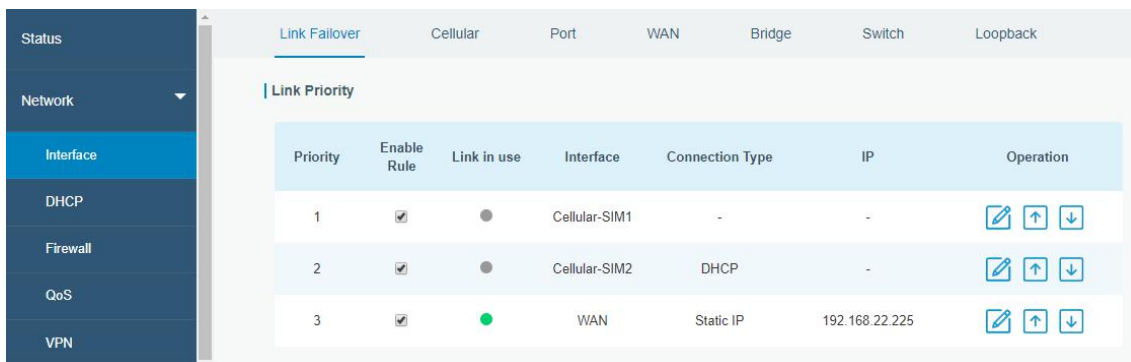

D. Click to configure ICMP ping detection information.

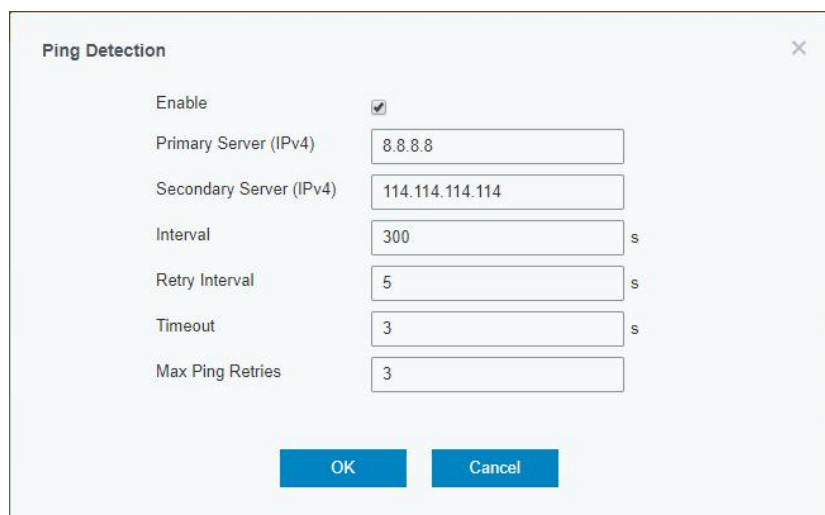

E. Click “Status > Cellular” to view the status of the cellular connection. If it shows “Connected”, it means SIM1 has dialed up successfully.

On the other hand, you can check the status of SIM indicator. If it keeps on green light statically, it means SIM1 has dialed up successfully.

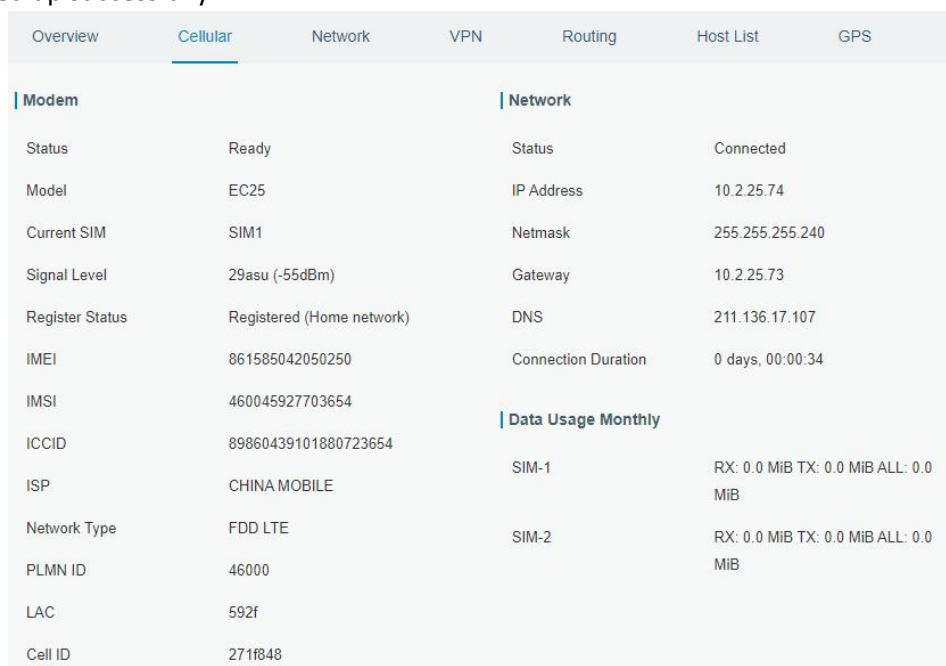

F. Open your preferred browser on PC, then type any available web address into address bar and see if it is able to visit Internet via UR35 router.

5.3 Ethernet WAN Connection

A. Go to “Network > Interface > WAN” to configure WAN parameters.

Take static IP configuration as an example. DHCP client and PPPoE type are optional according to your requirements.

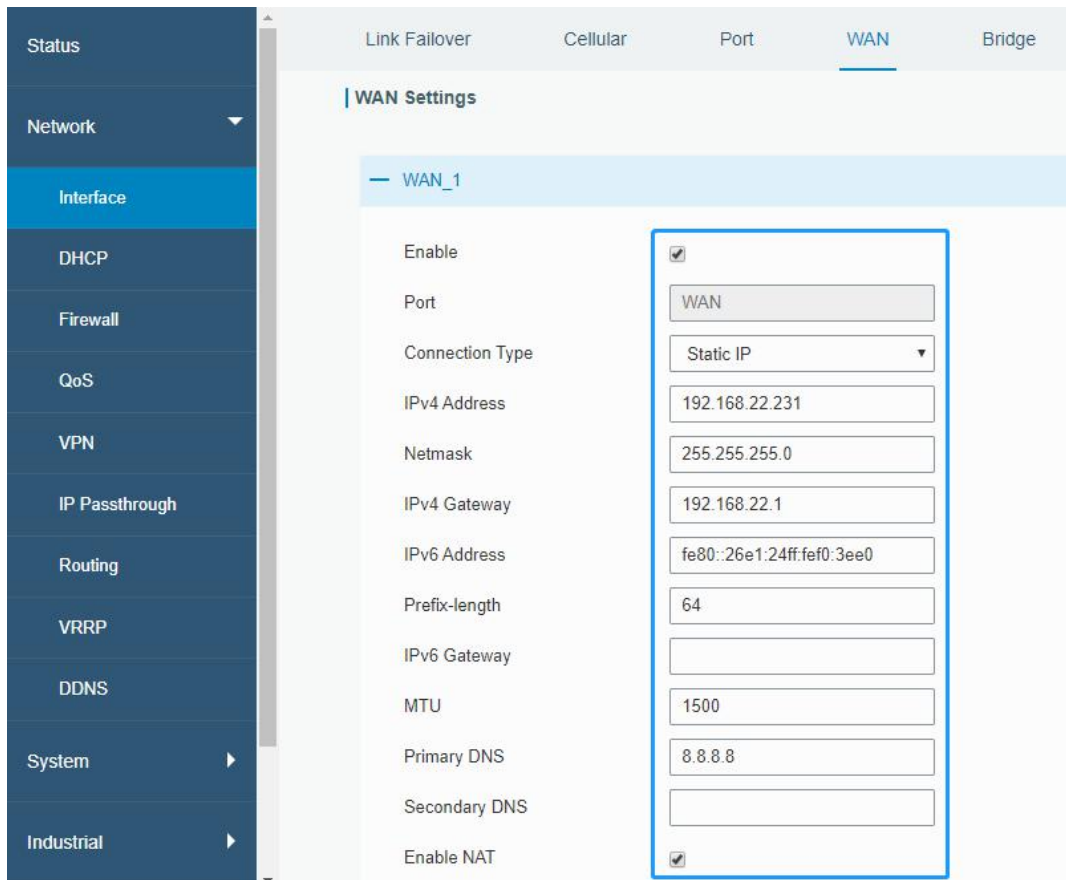

Click “Save & Apply” button to make the changes take effect.

C. Go to “Network > Interface > Link Failover” to rise the WAN priority to 1.

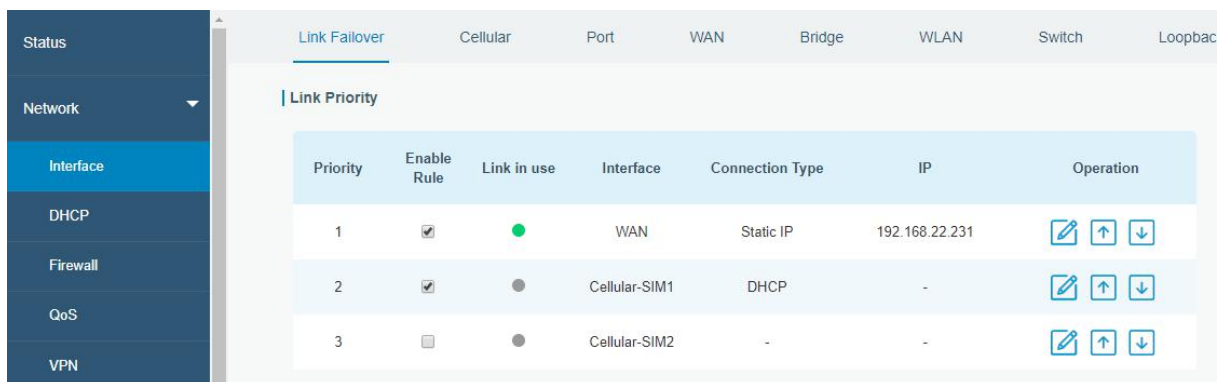

D. Go to “Status > Network” to check if status is “up”.



Port	Status	Type	IP	Netmask	Gateway	DNS	Connection Duration
WAN	up	Static	192.168.22.231	255.255.255.0	192.168.22.1	8.8.8.8	18h 54s

E. Open your preferred browser on PC, then type any available web address into address bar and see if it is able to visit Internet via UR35 router.

[END]